

TRUMPF



TruBend

Think ahead.
Bend better

Attention to every detail

Innovative ideas drive forward bending – and therefore your company, too. Modern bending machines from TRUMPF impress with functions that save resources, make operation easier and ensure precise quality – from the very first part. Whether it's laser-measured angles, energy-saving hydraulics or fully automatic tool changes – find out more about how you can make your bending production even more successful on the following pages.



Appropriate:

- Choose from the largest range on the market

Modern:

- Digital functions provide precise results

Simple:

- Fun operation that is easy to learn

FACTS AND INNOVATIONS

You can't bend the facts _____	4
Applications	

HIGHLIGHT FUNCTIONS

Producing the complete spectrum of products _____	6
Part variety	
Precise angles from the very first part _____	8
Quality	
Reducing setup times all round _____	10
Productivity	
Bending is team work _____	12
Ergonomics	
Intuitive operation and programming _____	14
Programming	
The right tool for any eventuality _____	16
Tools	

MACHINES

TruBend Series 1000 _____	20
The efficient basic machine	
TruBend Series 3000 _____	22
The cost-efficient standard machine	
TruBend Series 5000 _____	24
The productive all-round machine	
TruBend Series 7000 _____	26
The ergonomic high-speed machine	
TruBend Series 8000 _____	28
The flexible large-format machine	
TruBend Series 8000 (new generation) _____	30
Flexible, next-generation large-format machine	
Tandem version of the TruBend Series 8000 _____	32
For double the press force and double the bending length	

AUTOMATION

Automatically successful _____	34
Individual automation	
ToolMaster _____	36
Change tools automatically	
Flex Cell _____	38
The fastest mobile bending cell from TRUMPF	
TruBend Cell 5000 _____	40
The productive universal bending cell	
TruBend Cell 5000 Lean Edition _____	44
The economical, productive bending cell	
TruBend Cell 7000 _____	46
The innovative high-speed bending cell	

TECHNICAL DATA

Figures _____	50
All details at a glance	

SERVICES

TruBend Center _____	56
Spotlight: Panel bending	
TruServices _____	58
Your Partner in Performance	
TRUMPF _____	59
Passion is what drives us	

You can't bend the facts

Bending sheet metal with 1,000 tons of press force precisely to 0.3°?

TruBend machines make it possible. This page shows fascinating facts and illustrates what you can bend under optimum conditions.

30%

weight savings with
lightweight bending tools

TRUMPF has delivered over

540 km

of bending tools to date

30°

bends due to
bending aid

You can bend

1,000 t

of large and thick
parts powerfully

0.3°

can be bent

Positioning precisely to

0.002 mm

2,500 mm/s

backgauge for fast station operation



Work preparation

Be better prepared for bending

Programming is essential when it comes to bending. Programs such as TecZone Bend simulate the bends in 3D and automatically check feasibility. This decreases the mental effort you need to put in, saves time and avoids rejects.

Setup

Change tools more quickly

Setup is a part of bending. It is faster and easier with the automatic tool changer, tools with a lightweight design, and automatically prepared and optimized setup plans.

Production

Produce precisely

It all depends on the angles. Whether you bend manually or automatically – intelligent functions ensure precision and productivity in your production.

Producing the complete spectrum of products

Whether you are bending delicate or oversized parts: use the widest machine range on the market to meet your various requirements – simply and without compromise.

Any component geometry

Regardless of whether it's thick, thin, large or small parts – with bending machines from TRUMPF you can produce an enormous part variety. Due to the large range of TruBend machine variants, you can process any component geometry cost-efficiently and in top quality. You benefit from:

- various tonnages and bending lengths
- a large material range from aluminum to Hardox
- precise positioning of your parts with 2-, 3-, 4-, 5- or 6-axis backgauge systems

Any part size

If you normally bend large parts, the option increased open height might be of interest for you. In contrast, the TruBend Series 7000 and the automatic TruBend Cell Series 7000 are specialized for small parts. Bend with flexibility:

- With a press force of up to 1,000 metric tons
- Parts of up to 8 m in length
- Box heights of up to approx. 518 mm

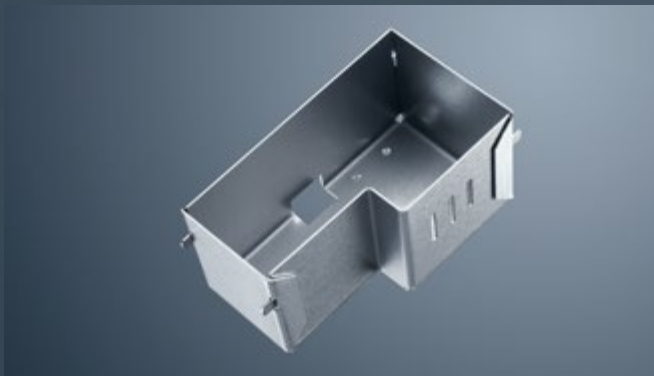

Depending on the machine, you can bend box heights of up to 518 mm.



Precisely realize even complex parts with many bends.



Through thick and thin

Does the sheet thickness vary from batch to batch? No problem – the Thickness Controlled Bending (TCB) function automatically compensates for variations. Sensors detect the actual thickness of each sheet and adjust the pressing depth of the upper tool accordingly. This means that you can achieve precise angles regardless of the sheet thickness – without loss of productivity, calibration and programming effort.

Precise angles from the very first part

Perfect angles are what really counts when it comes to part quality during bending. If they are right from the very first part, you prevent rejects and don't waste material or time. You have to be able to rely on your parts being identical in series production – you don't want to have to measure every angle again at the end. This isn't necessary with a TruBend machine, because it offers you valuable additional benefits.

Precise angles right away

Numerous factors influence angle precision when bending, for example fluctuating strengths in the material or springback. The solution: automatic angle measuring systems from TRUMPF – they enable you to bend perfectly from the very first part in a series. ACB stands for "Automatically Controlled Bending." The ACB systems' sensors record the actual angle and springback and control the press beam so that the desired angle is bent – quickly and precisely. The two ACB Laser and ACB Wireless systems complement one another; one system may be more appropriate than the other depending on the application.

Tactile process: ACB Wireless

The user-friendly system measures and corrects angles using two sensor disks that are integrated into the upper tool. These sensor disks come into contact with the inner surface of your bending part during bending. In doing so, together with sensors, they measure the precise angle electronically and ensure that it is perfect. The control and the angle measuring system communicate wirelessly here.

Optical process: ACB Laser

Without any setup required – with ACB Laser you can use a non-contact, optical system for angle measurement. This means that two measuring units move in front of and behind the bending line independently of one another. Each unit consists of a laser and a camera. The laser projects a line onto the sheet metal; the camera detects this line and calculates the angle of the bending part in real time.

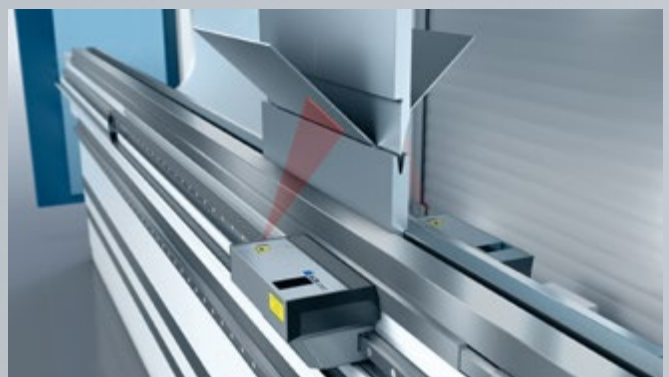

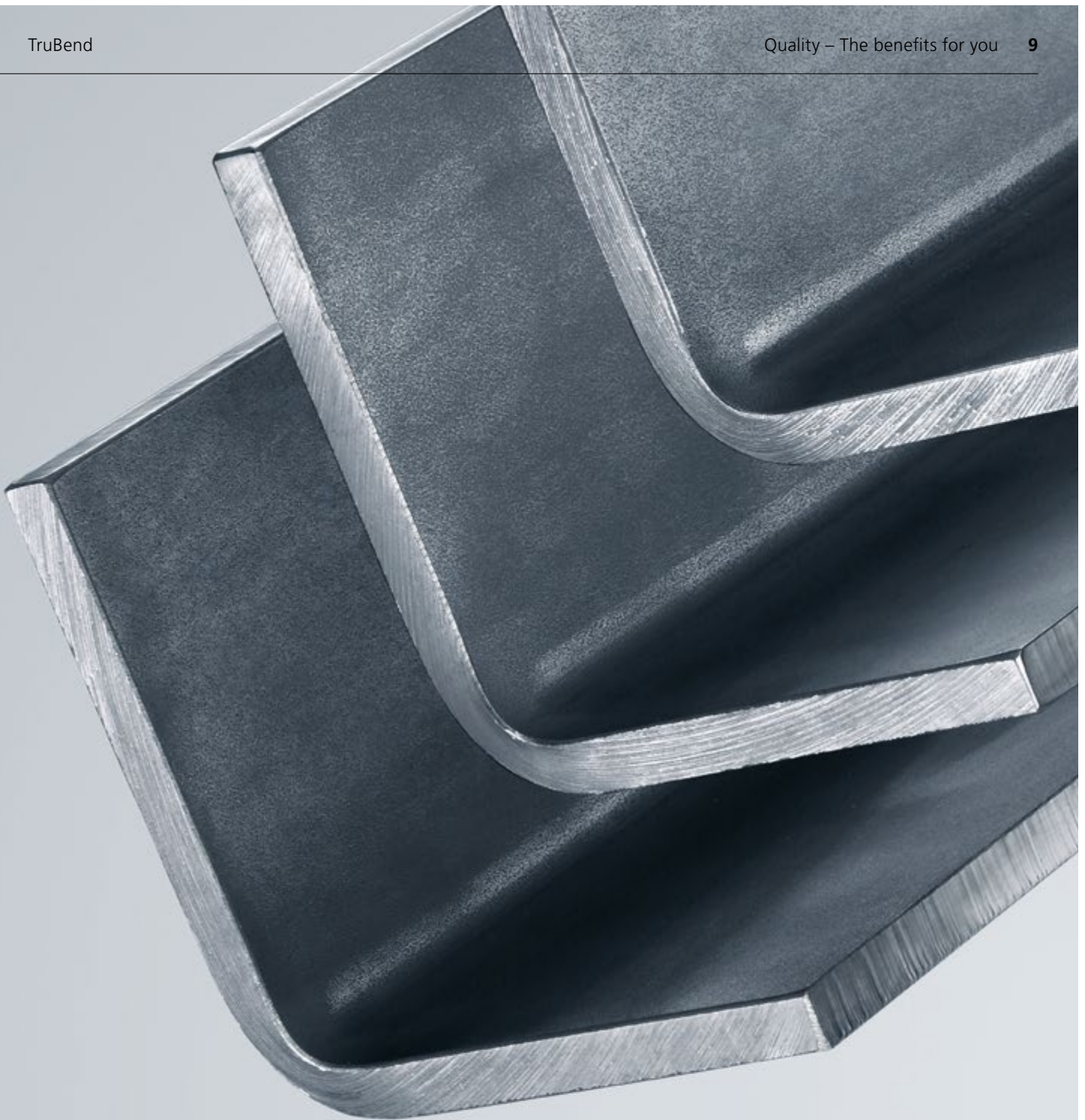

Strengths of ACB Wireless

- Particularly suitable for:
 - Short flanges
 - Reflecting surfaces
 - Interior tabs
- Quick station bending
- Quick multi-point measurement

Strengths of ACB Laser

- Particularly suitable for:
 - Acute and obtuse angles
 - Thick sheet metal
 - Large radii
- No set-up required
- System is suitable for all tools
- Use of special tools possible
- Low interference contour
- Completely mark-free
- Quick multi-point measurement

■ High speed

■ Perfect angles

■ Various bending methods possible

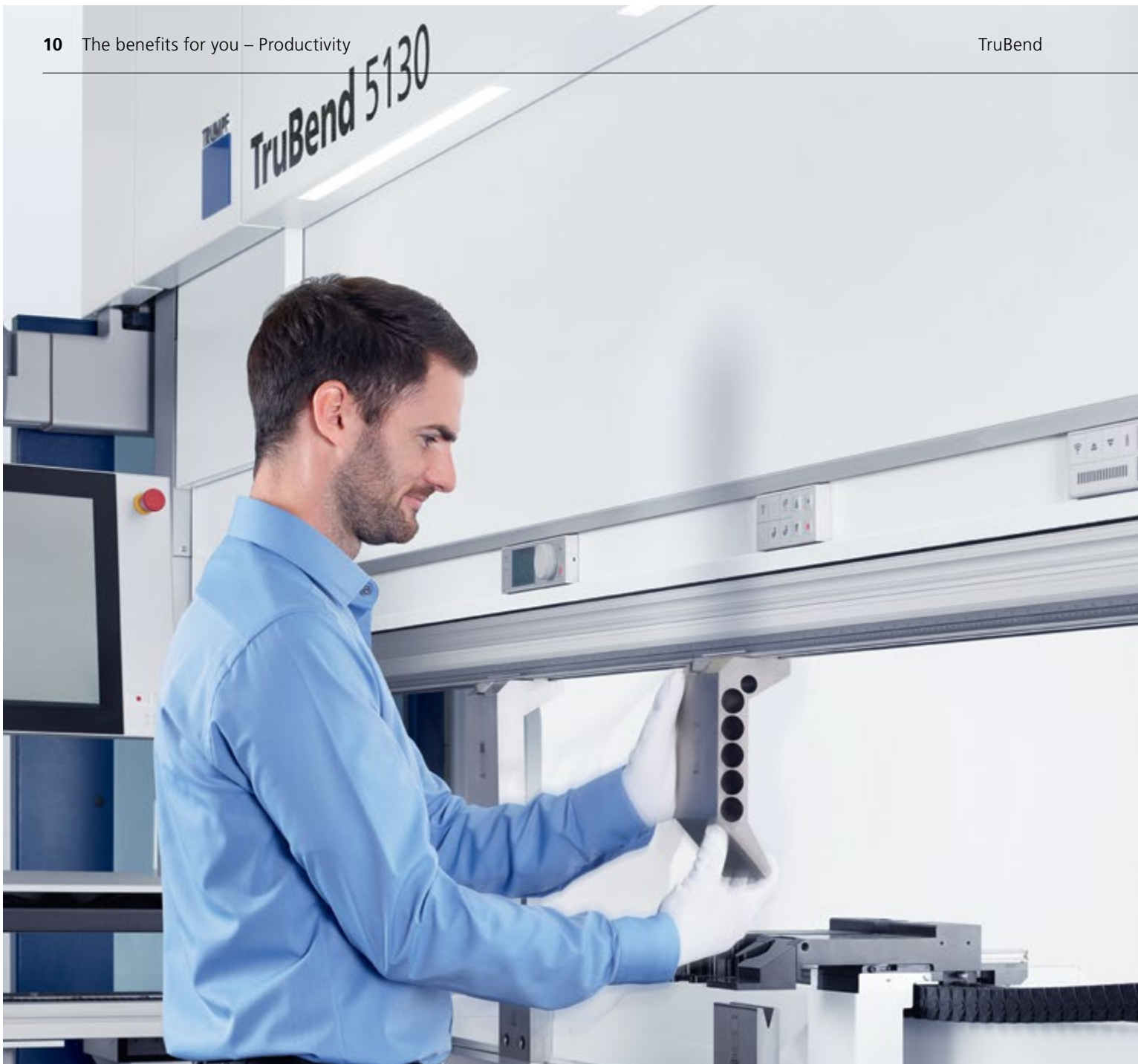

Reducing setup times all round

From machine functions and tools to the software components – reduce your setup times to a minimum. You can achieve this with the aid of our unique overall concept. Read more about some of its components on this spread.

Lightweight bending tools: 30% less weight

With the Safety-Click safety mechanism you can change the upper tools from TRUMPF quickly and safely. The operator simply clamps the tool into and out of the machine clamp from below. Patented lightweight bending tools from TRUMPF weigh around 30% less than conventional upper tools but are just as durable and resilient. This means that the operator doesn't have to lift such heavy loads and can set up more quickly.

BendGuard: Automatically safe

Due to the BendGuard, you no longer have to adjust any safety devices manually on your bending machine. For the CNC-controlled variant, the BendGuard moves independently to the height of the set-up tools. This means that you avoid errors and save manual interventions and setup time.

ToolShuttle: Change tools simply

Manual setup made easy? This can be achieved with the ToolShuttle. You can ergonomically move the tools from the tool magazine to the setup position via a moving table – this makes handling easier, particularly of large and heavy tools. Your tools are also secure in the ToolShuttle – the closed storage prevents corrosion or dirt, the tools do not slide about, and searching time is also reduced.



The ToolShuttle allows you to set up heavy tools quickly and simply.

Tool Setup Optimizer: Optimizing the setup process

You can save even more time now thanks to the Tool Setup Optimizer: While TecZone Bend is swiftly generating the bending programs for your bending parts, the Tool Setup Optimizer then checks which parts can be bent using the same tools and which tool stations can be best combined in which manner – and all in just a few seconds. This means that you change the setup of as few tools as possible, saving time and energy – and you can get on with bending more quickly.

ToolMaster: Change tools automatically

The ToolMaster automatically sets up your bending machine for every new program. An invaluable benefit, especially in case of small lot sizes, as you save time and effort. Find out more about the functions and benefits of the ToolMaster on pages 36 and 37.

Tool Indicator: Position precisely

Due to the LED bar in the upper tool clamp, you can set up in no time – it shows you exactly where the tool stations have to be set up. It also visualizes which tool station the next bend is to be carried out on.



During set up the Tool Indicator shows precisely where the bending tools have to be used.



Bending is team work

The team made up of human and machine is critical to success during bending. If the operator is at ease, the machine can deliver its full potential. A bending machine from TRUMPF therefore does everything it can to make the operator's work easier. From the quiet drive to the optimal illumination and customizable screen to smart highlights: Simple operation and ergonomic design ensure more fun when bending and more physical relief for the bending specialist.

A few examples:

MobileControl: For less time spent moving about

The smart helpers MobileControl and MobileControl Pro ensure that you spend less time moving around. As movable operating units in a rail on the press beam, they include the most important functions, meaning that you can change the machine parameters in an instant – without constantly having to go to the control panel.



Bending aid: Lift sheet metal easily

Over time, bending large and heavy parts has a negative impact on the health of even the strongest operators. The bending aid from TRUMPF prevents the problem before it starts. It aids bending of weights of up to 300 kg, relieves the operator in the case of angles of up to 30°, and can be automatically adjusted in height.



Wireless foot switch: For safe operation

Safety is important for ensuring that every operator can work optimally. The TÜV-tested wireless foot switch provides increased freedom of movement and eliminates the tripping hazard.



Part Indicator: For minimal rejects

The Part Indicator shows to the operator on the screen how they should position the bending part. The next insertion position is then always shown. A colored marking indicates whether the part has been placed correctly. This reduces rejects, particularly in the case of inexperienced operators.

Intuitive operation and programming

With TRUMPF, benefit from the enormous potential for time savings when controlling and programming your bending machine. Touchpoint Bend combines the advantages of state-of-the-art multi-touch technology and industrial control. This makes operating your bending machine as simple and intuitive as using a tablet or smartphone. Programming 25 parts in 18 seconds? Benefit from the quickest and simplest bending programming currently on the market: TecZone Bend.

A dialog between operator and machine

Touchpoint Bend is the simple interface for operating your bending machine. Navigation follows an intuitive logic. The displays are reduced to their essentials; realistic 3D visualizations with collision check make processing easier. The right solution is therefore achieved for each application – from simple to complex components. The integrated aid also makes machine operating easier; it can be called up using twofinger operation and simple touch gestures such as swiping.

TecZone Bend is the quickest and simplest programming system for manual and automated bending machines and a great help for any operator. This means that you can carry out programming either at the machine or offline in the office and can switch seamlessly between these two aspects. The TRUMPF software automatically generates program proposals, including NC programs, based on 2D and 3D data. It calculates your bending programs in seconds – including collision check in real time, dismantling assemblies, managing setup plans, and much more. Prioritization of tools reduces work outlay and increases the productive operating time of your machine. The optional Tool Setup Optimizer greatly improves the setup process.



Touchpoint Bend: simple and intuitive operation.



Call up the programs easily using the 2D code scanner.



Access the right program automatically

Access the right bending program in an instant with the 2D code scanner. The scanner, which is connected to the machine, reads a bar code or Data Matrix Code from paper and automatically loads the program. This saves you entry and search outlay.

The right tool for any eventuality

Your bending machine provides top performance every day. All components have to interact to ensure this. This is why we don't just provide detailed advice, but also produce all tools ourselves – durable, precise and perfectly coordinated to your TruBend machine. Choose from the widest range of tools on the market. Our specialists also develop special tools to suit any requirement.

Durable with built-in added value

Wear-resistant working areas make your tools particularly durable. This is why laser beams harden them precisely where it matters – on the surface. The interior remains elastic to ensure that the tool does not splinter during overload. High-quality coatings such as LASERdur AL and LASERdur ZN prevent unwanted adhesion of aluminum or zinc due to abrasion of the sheet metal. This means that there are outstanding glide characteristics and no marks or imprecision. Your tools are also corrosion-resistant and do not have to be cleaned.

Bend without leaving any trace

When bending visible parts it is particularly important that you do not leave any marks on the sheet metal. You can achieve this with the RollBend tool. It enables you to create short flange lengths, as well as moldings and holes close to the bending line, without causing deformation. You can easily combine it with standard dies.

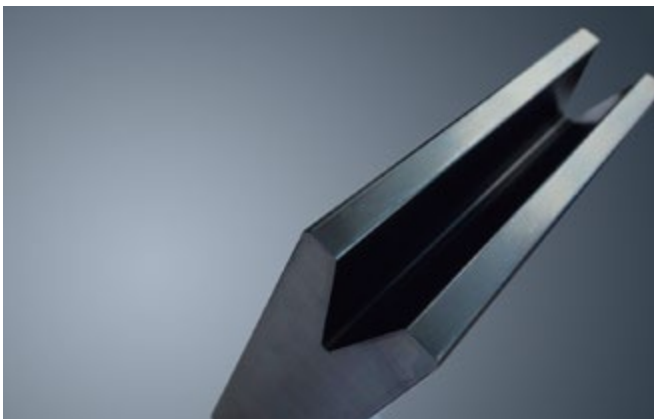

Ensure your tools have a high level of surface hardness and outstanding glide characteristics – the LASERdur AL and LASERdur ZN hardening processes.



With the RollBend tool you can create short flange lengths, as well as moldings and holes close to the bending line, in a low-mark manner and without causing deformation.



For perfect interplay with your machine, we produce all bending tools ourselves. You can obtain more than 150 upper and lower tools ex stock – as a set or individual parts. We develop, test and produce special tools in accordance with your specifications for particular requirements.



You can find **more information about TRUMPF bending tools** at www.trumpf.com/s/hup25d



To ensure you bend correctly

Whether you are a specialist for small or large parts, want to bend productively as an all-rounder or rely on fully automatic bending cells – you have the choice. On the following pages, you can find bending machines with intelligent functions for every requirement – to ensure you're always on the right track when it comes to bending.





nd 5130

TruBend 7100

TruBend Center 1100



Find more information on TruBend machines
at www.trumpf.com/s/hup25d



TruBend Series 1000

The efficient basic machine impresses with its simple operability, high precision, and the familiar TRUMPF safety standards. Fast set-up as well as simple and smooth operation with minimal downtimes offer you the perfect introduction to the TRUMPF bending world.

01

Intuitive operation

get started right away

02

Precise bending

even for complex parts



03

High machine availability

with the TRUMPF ECO system

04

Fast set-up

for smooth operation

01

Intuitive operation

get started right away

The TruBend Series 1000 is fitted with a control system developed in-house and enables quick and easy numerical and graphical programming.



The TRUMPF control system makes programming easy.

03

High machine availability

with the TRUMPF ECO system

Embedded in the TRUMPF ECO system, the BendGuard ensures reliable bending. The globally available TRUMPF Remote Services ensure fast customer service and high machine availability.

02

Precise bending

even for complex parts

The 4-axis backgauge ensures the correct positioning of the sheet and enables you to bend even complex parts with high repeatability without any problems.



The 4-axis backgauge enables you to bend complex parts.

04

Fast set-up

for smooth operation

The TRUMPF hydraulic upper tool clamp simplifies tool changes. This means you can now set up faster and easier than ever before.



More information on the impressive functions of the TruBend Series 1000:

- BendGuard (page 11)
- TecZone Bend shop floor programming and offline programming (page 14)

This machine is only available in selected countries. Please contact our sales team for more information.



Get more information about the TruBend Series 1000 at www.trumpf.info/subr82



TruBend Series 3000

The cost-efficient standard machine – combines top TRUMPF quality with simple operation and an attractive price-performance ratio.

01

Easy to operate
and program

02

Compact design
for symmetrical transmission of forces

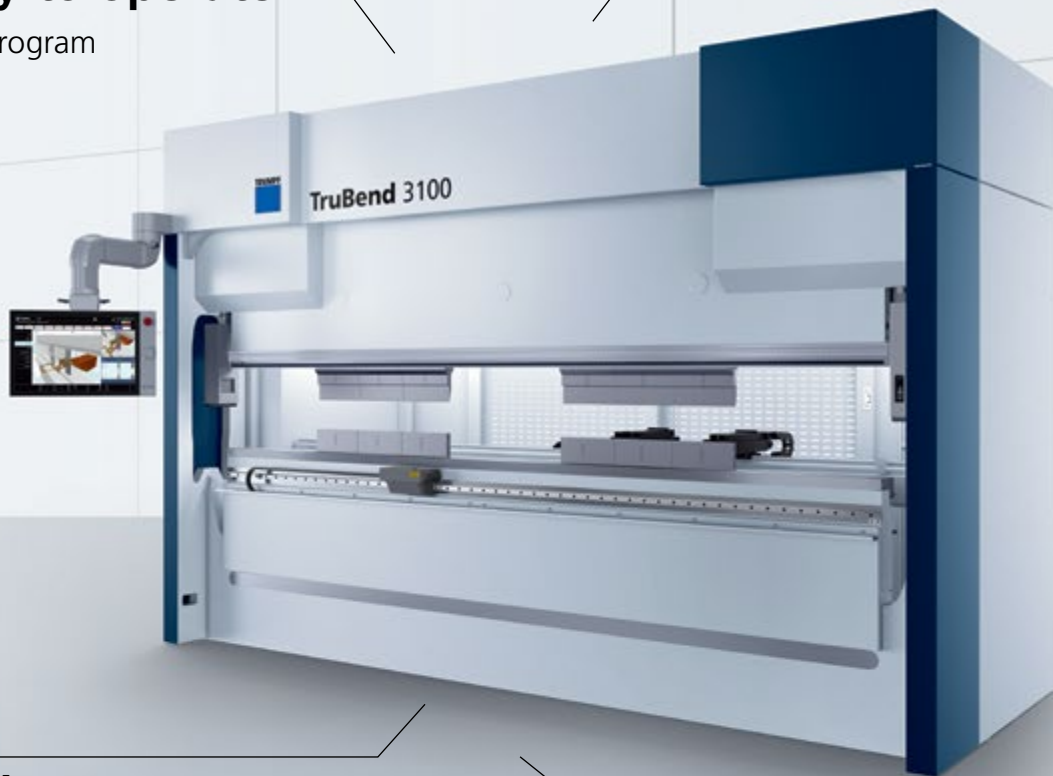

03

Flexible setup
using the system

04

Precise angles
measured by laser

01

Easy to operate

and program

You can also produce cost-efficiently with low capacity utilization with the machines from the TruBend Series 3000. Furthermore, you benefit from top safety standards. You can carry out graphical programming directly at the T4000S controls by quickly importing externally created 2D DXF drawings. Tool data in DXF format can be imported quickly. TecZone Bend, the quick and easy programming system, is also available as an offline version.



The state-of-the-art multi-touch controls are clearly organized, straightforward and self-explanatory.

03

Flexible setup

using the system

The tool handling is thoroughly well thought-out – self-centering tools reduce setup times; wear-resistant tool clamps ensure quality in the long run. You can set up upper tools of up to 13.5 kg from below quickly with the aid of Safety-Click. You can also insert tools so they are rotated in the mounting.

02

Compact design

for symmetrical transmission of forces

The compact architecture with hydraulic drive ensures a symmetrical transmission of forces. The entire bending length can be used without limitations here. The crowing facility guarantees uniform, precise angles, even with large bending lengths. That and their 4-cylinder technology make the machines of the TruBend Series 3000 the fastest bending machines of their class.



The 2-, 4- or 5-axis backgauge makes the machine quick and precise.

04

Precise angles

measured by laser

The TruBend Series 3000 is the only machine in its class with which you receive the ACB Laser angle measuring system. The laser and camera automatically check whether all angles are correct during the bending operation. The non-tool-based measurement system means no marks, no setup outlay and top part quality without rejects.

More information about the impressive functions of the TruBend Series 3000:

- System for perfect angles (page 8/9)
- TecZone Bend offline programming (page 14)
- 2D code scanner (page 15)



Find more information about the TruBend Series 3000 at www.trumpf.com/s/kx4t6m



TruBend Series 5000

The productive all-round machine – with its high number of benefits and functions during programming, setup and operation, you achieve unrivalled productivity during production.

01

The productive multi-purpose machine

precise and flexible

02

Turbo

for your programming

03

Efficient and economical

energy on demand

04

Easy to operate

with handy extras

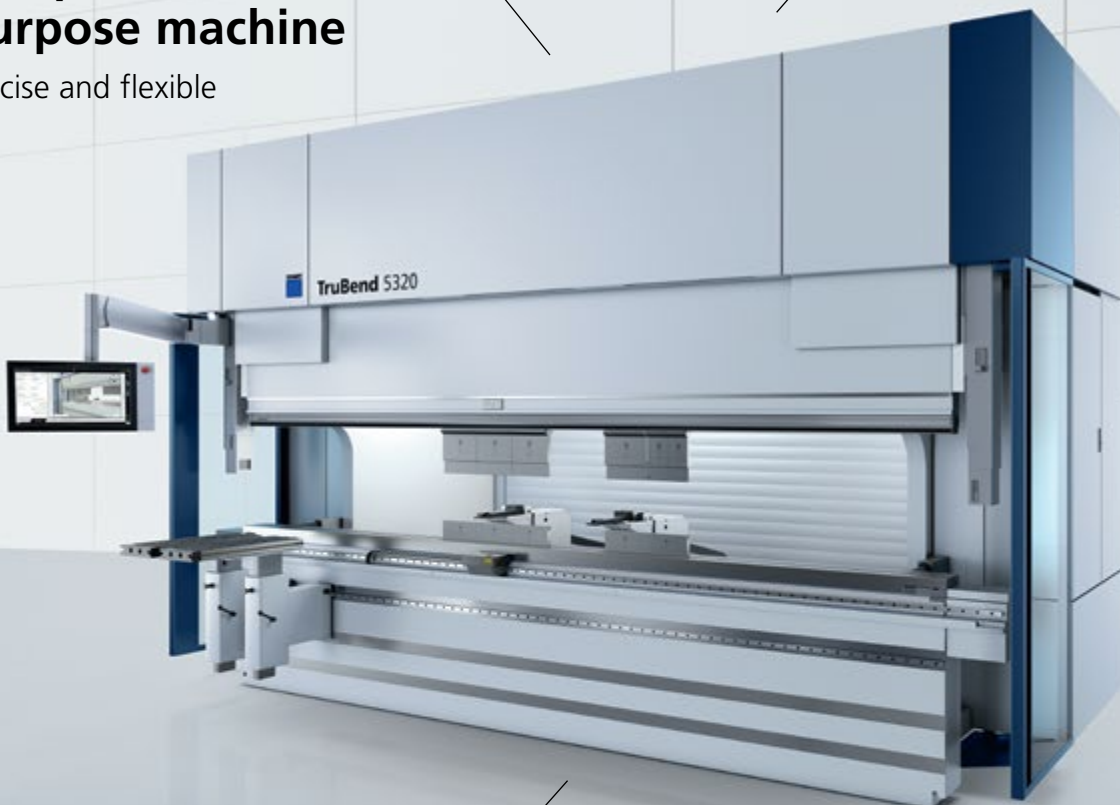

01

The productive multi-purpose machine

precise and flexible

Everything it does, it does quickly and precisely – among other things, sophisticated angle measuring systems such as ACB Wireless and ACB Laser ensure precise angles from the very first part – regardless of the material properties. It is user-friendly, saves rejects and increases your productivity, as it reduces outlay for running in. Choose the right solution for every application – the two independent angle measuring systems can be combined with one another.



Precise angles due to laser measurement – ACB Laser.

03

Efficient and economical

energy on demand

The third generation of the TruBend Series 5000 makes the operator's daily work easier due to a variety of innovations. This includes comfortable and ergonomic control via wireless foot switch or MagicShoe, which you can use to trigger the stroke directly. With the MobileControl system, you can save walking time, which is a great advantage when it comes to a 4-m-long machine. The On-Demand Servo Drive thus saves up to 42% in energy compared to traditional hydraulics.

02

Turbo

for your programming

Your machine grows with you – with the ToolMaster tool changer you can set up automatically. You can also upgrade it to the automated bending cell TruBend Cell 5000. Minimize the number of tool changes using the Tool Setup Optimizer option. This not only saves time and effort – most importantly, it also allows you to bend more productively and efficiently.



The ToolMaster now includes even more tools.

04

Easy to operate

with handy extras

The handy bending aid for angles of up to 30°, including automatic height adjustment, provides valuable assistance. In particular, it helps when bending heavy or large parts. You can choose between either plastic, brushes or rollers as support. The Part Indicator positioning aid makes correctly inserting the component into the machine easier – safety is increased for the operator and you reduce rejects.

More information on the impressive functions of the TruBend Series 5000:

- System for perfect angles (page 8/9)
- Tool Indicator (page 11)
- BendGuard (page 11)
- ToolMaster (page 11)
- Bending aid (page 13)
- TecZone Bend shop floor programming and offline programming (page 14)



You can find more information about the TruBend Series 5000 at www.trumpf.info/r96fp1



TruBend Series 7000

The ergonomic high-speed machine – it bends small and medium-sized parts under top work conditions in a space-saving and highly productive manner.

01

High output with top quality

due to direct drive and angle measuring systems

02

Quick and safe

due to BendGuard Automatic



03

Well thought-out space-saver

suitable for every production

04

Ergonomic operation

thanks to numerous equipment options

01

High output with top quality

due to direct drive and angle measuring systems

Energy-saving and highly productive – the directly driven torque motor produces a high torque even at a low revolution speed. This means that you can use large press forces at the same high working speed. The mass-reduced backgauge also ensures a high level of drive dynamics. You create the ideal conditions for maximum productivity along with the angle measurement systems.

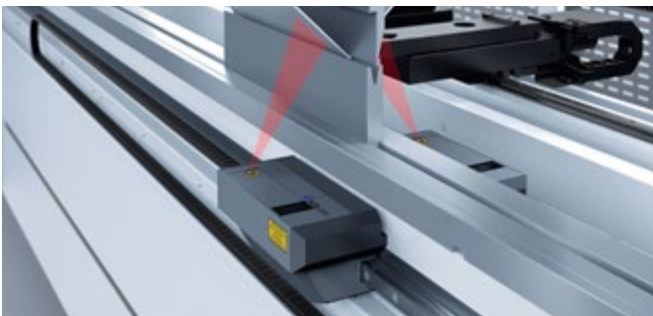

Its backgauge makes the machine particularly dynamic, and ACB Laser particularly process-safe.

03

Well thought-out space-saver

suitable for every production

Small and compact – with its low installation area, the TruBend Series 7000 is suitable for every production and can be transported by a forklift truck. When bending small and extremely small parts, the machine is a big help – due to the geometry of the gauge finger, you can also position parts with very small flanges with ease and collision-free. You can conveniently remove small parts directly after bending with the aid of a box.



More information on the impressive functions of the TruBend Series 7000:

- System for perfect angles (page 8/9)
- BendGuard (page 11)
- Touchpoint Bend (pages 14)
- TecZone Bend shop floor programming and offline programming (page 14)
- 2D code scanner (page 15)

02

Quick and safe

due to BendGuard Automatic

Two manual interventions fewer – manual adjustment of the safety device is now a thing of the past due to the BendGuard Automatic. With the help of the CNC control, the BendGuard moves independently to the height of the set-up tools. You save the usual manual interventions and valuable setup time, and can work safely and error free.



Automatic safety with the BendGuard Automatic.

04

Ergonomic operation

thanks to numerous equipment options

If things are good for the bending operator, things are good for the bending process – the TruBend Series 7000 is the first press brake to receive an ergonomics certificate. The operator works ergonomically with a sitting and standing aid; they can adjust the support table individually. The sitting and standing aid as well as the swiveling control are easy on the spine. LED lighting ensures top visibility in the work area. A laser that projects the line to be bent onto the sheet metal part provides intelligent assistance.



Find more information about the TruBend Series 7000 at www.trumpf.com/s/47yokz



TruBend Series 8000

The flexible large-format machine – with up to 1,000 t of press force, it bends small, large, or extra-large parts powerfully and precisely.

01

Bending complex parts

even with extremely large sizes

02

Simple setup

even with heavy tools



03

Quick installation

due to surface-mounted design

04

Powerful bending

with an especially high press force

01

Bending complex parts

even with extremely large sizes

The TruBend Series 8000 processes large and oversize formats in a versatile manner and extremely precisely, for example due to the LCB (Laser Controlled Bending, similar to ACB Laser) laser-based angle measuring system version. With a particularly large usable open height and throat depth, 8 m of bending length, and up to 1,000 metric tons of press force, even high-tensile materials and long flanges are no problem. You can bend smaller workpieces on multiple tool stations; the machine can even achieve Z bends perfectly – a true all-rounder.

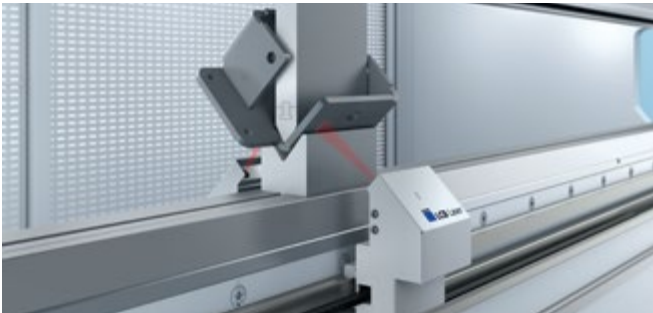

LCB (Laser Controlled Bending) – the laser-controlled goniometer version of the TruBend Series 8000.

03

Quick installation

due to surface-mounted design

Surface-mounted versions of up to 6 m save you from needing expensive foundations. This therefore doesn't just reduce the investment required, you can also position the machine independently and move it around. If you eventually resell the machine, you will benefit from stable prices in the second-hand market, as your buyer does not have to provide foundations.

More information on the impressive functions of the TruBend Series 8000:

- System for perfect angles (page 8/9)
- ToolShuttle (page 11)
- TecZone Bend offline programming (page 14)
- 2D code scanner (page 15)

02

Simple setup

even with heavy tools

Large bending parts require large tools. Despite this, the TruBend Series 8000 can be set up quickly and easily due to the ToolShuttle – the operator moves the tools from the tool magazine directly into the machine ergonomically and safely. The ToolShuttle has over 160 m of load capacity and stores your tools so that they are well protected.



The ToolShuttle sets up your tools quickly and ergonomically.

04

Powerful bending

with an especially high press force

However, the crowing facility and tool clamp of the TruBend Series 8000 are extremely sturdy with capacities of up to 6,000 kN per meter. The automatic crowing facility provides high productivity and precise angles over the entire bending length. Alternatively, adjust the crowing curve point by point every 250 mm. A further advantage: like all bending machines from TRUMPF, the TruBend Series 8000 also has no unnecessary interference contours and thus makes parts handling easier.



Find more information about the TruBend Series 8000 at www.trumpf.com/s/7e30pl



TruBend Series 8000 (new generation)

The new generation of the flexible large-format machine – with options for heavy-duty bending and a variety of bending aids, it simplifies the processing of heavy, long, and tall workpieces.

01

Precise angles
from the very first bend

02

Convenient operation
and intuitive control



03

Large and strong
for long, heavy and large-format parts

04

Energy-saving
and quiet bending

01

Precise angles

from the very first bend

Large format blanks are expensive. So it's good if the first bend is perfectly executed. The TruBend Series 8000 ensures this by using an entire team of tried-and-tested angle measuring systems. The Automatically Controlled Bending (ACB) Laser is an optical system for angle measurement. Its laser projects a line onto the sheet; the corresponding camera detects the angle. The ACB Wireless measures and corrects angles wirelessly using sensor disks in the upper tool. Other tools are Operator Controlled Bending (OCB) and the Thickness Controlled Bending (TCB) software.

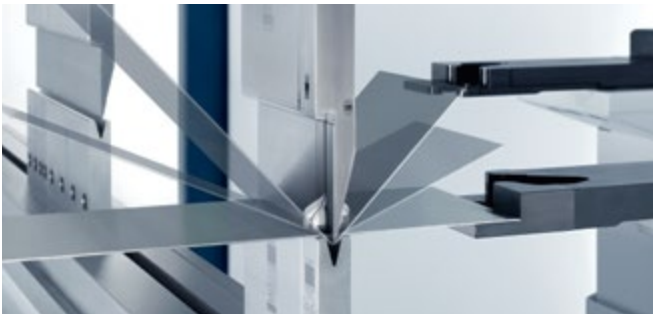

The proven ACB Laser and ACB Wireless angle measuring systems are now also available on the new generation of the TruBend Series 8000.

03

Large and strong

for long, heavy and large-format parts

With its large installation height and throat depth plus its enormous press force, the TruBend Series 8000 is the first choice for bending heavy, long and tall components. Thanks to up to 6,000 kN/m, their crowning facility and tool clamps can withstand any load. The automatic crowning facility is not only powerful, but also extremely precise. If necessary, adjust the crowning curve to precisely fit your bending task at a distance of 250 mm.



More information on the impressive functions of the new generation of TruBend Series 8000:

- System for perfect angles (page 8/9)
- ToolShuttle (page 11)
- TecZone Bend offline programming (page 14)
- Tandem version (page 32/33)

02

Convenient operation

and intuitive control

Options such as support brackets and bending aids make working on the TruBend Series 8000 machines ergonomic, safe and productive. Its robust multi-touch control is logical and can be operated intuitively. One highlight is the lower tool displacement. This allows you to use one tool for two different bending processes, increases your part variety, and saves setup time and investment costs. In addition, the lower tool displacement enables special applications such as folding.

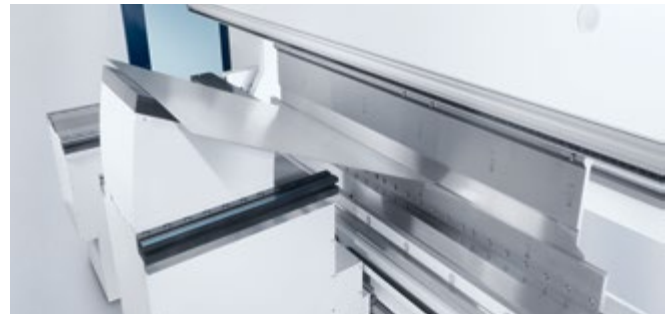

The automatically height-adjustable bending aid supports your bending staff.

04

Energy-saving

and quiet bending

With the on-demand drive, you can achieve up to 26% energy savings and bend extremely quietly. This is because the revolution speed of the motor automatically adapts to the movement of the press beam. The sustainable on-demand drive is available as an option for your variant of the new TruBend Series 8000 – which you can use to bend quickly and energy-efficiently over the long term, and with low-noise.



More information on the new generation of the TruBend Series 8000 can be found at www.trumpf.info/pqu641



Tandem version of the TruBend Series 8000

Operate two perfectly attuned machines individually or together as one machine – for double the press force and double the bending length.



Large format in duplicate – for any situation

Do you bend both 6 m or 8 m long parts as well as short sheets? Then you need a flexible solution – the tandem version of the TruBend Series 8000. Two machines act synchronously and thus double the bending length and press force here. You can achieve longer flange lengths due to a large throat depth and can increase your part variety. You can also use each machine individually, meaning that you have two machines available for short parts. The result: more capacity, more productivity, more orders processed.

Easy to operate over 8 m too

You can even save money during installation due to the surface-mounted installation. Clever helpers such as MobileControl, the multi-touch control or the bending aids are also there to support you in the tandem design – they make working over long distances easier and allow you to produce extremely professionally.

Productive and reliable over the whole length

You can carry out two different bending operations with one tool using the lower tool displacement, even in tandem mode. This increases your part variety and saves setup time and investment costs. The BendGuard ensures safe working across the entire tandem bending length.



More on the topic
of tandem bending
on TRUMPFtube:
[www.trumpf.info/
5yov12](http://www.trumpf.info/5yov12)

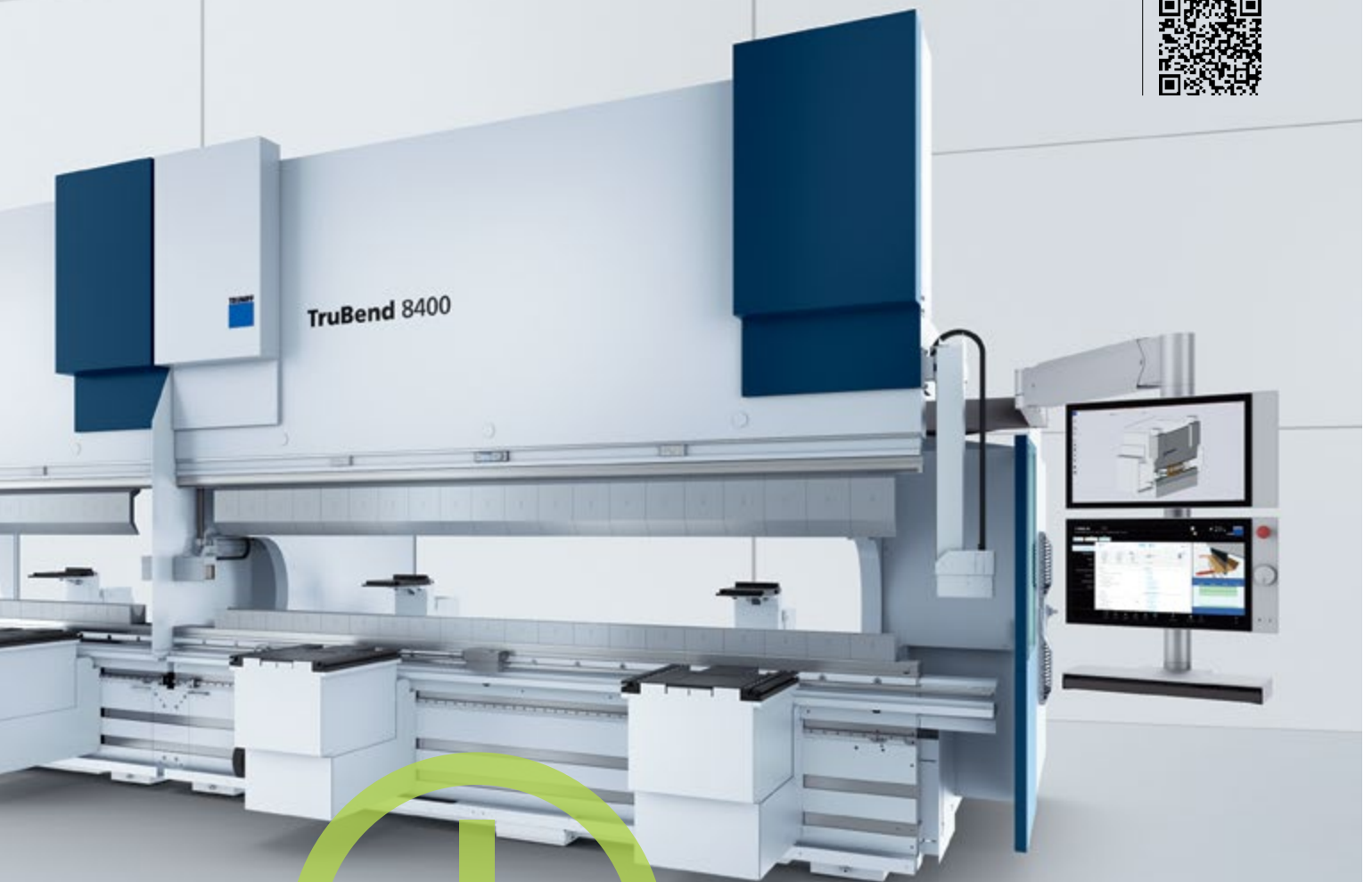

When is your tandem day?

A tandem facility is worthwhile even if you only occasionally bend oversized parts. Simply use the machine as a tandem facility on certain days; the two machines can produce independently of one another during the rest of the week.

Special machines

Do you have very special requirements when it comes to bending length, press force, backgauge, open height or tool system? Due to decades of experience in building customized bending machines, we will, of course, help you in developing special machines.

Automatically successful

You produce particularly cost-efficiently with an automatic bending cell – around the clock if required. You reduce your cycle times and bend with minimal personnel effort. The continuously high quality of your components saves reworking and rejects. When do you start bending successfully automatically?



1. The right machine

Your TRUMPF bending cell suits you – choose the right machine type and the right machine size depending on the range of components.

2. Automatic setup

Automatically set up your bending machine for each new program with the ToolMaster tool changer. An invaluable advantage, even in case of small lot sizes. You save time and effort.

Why TruBend Cell?

To ensure that your processes run reliably and productively, we develop comprehensive solutions made up of bending machines, bending tools and automation. This also includes software, sensor systems, material flow and state-of-the-art gripping technology.

Keep a tight grip on your production

The BendMaster carries out gripping and moving during automatic bending. With its vacuum gripping technology, it reliably handles components of up to 100 kg in weight and up to 4 m in length. The nimble pivoted-jaw gripper moves the small components. It skillfully removes small parts at the sheet removal station and provides them parallel to production. Depending on what you need and on which machine you carry out production, we recommend the pivoted-jaw and vacuum gripper technology.

Reliable due to sensors

Sensors ensure reliable material handling. This ensures consistent quality. The sheet sensor identifies blanks that are not centered – due to it, the gripper is able to pick up the blank in the correct position. Weight sensors ensure that only individual sheets are always lifted. The sensor system in the backgauge fingers ensures quick and precise positioning of your parts.



3. Produce automatically

Process a wide range of components with low part costs and high reliability standards. The universal offline programming saves time – create programs parallel to production at the workstation.

4. Customize completely

We also provide customized options when it comes to system technology and robotics. Do you require multiple robots or want to connect handling equipment? Are you looking for a solution for unusual circumstances? Simply contact us; we will be happy to advise you.



Find more information about automation for bending machines at www.trumpf.com/s/uda429



ToolMaster

Make searching for and moving tools a thing of the past: the tool changer sets up your bending machine for the next task automatically – the new generation is faster than ever. This doesn't just save time and effort, it also particularly increases your productivity.

Change tools automatically

Retooling a bending machine during each program change is laborious. The ToolMaster carries out these setup operations for you. It can now do even more: It uses standard tools, ACB tools, tools with adapters and has space for up to 60 m of tools on average – depending on the tool, even more is possible.

You can carry out other tasks while the ToolMaster automatically sets up your tools. This really pays off, particularly when it comes to small lot sizes. Searching and walking times are eliminated completely. Its positioning accuracy makes station operation easier for you. A further benefit – the closed storage protects your tools from dirt and corrosion.



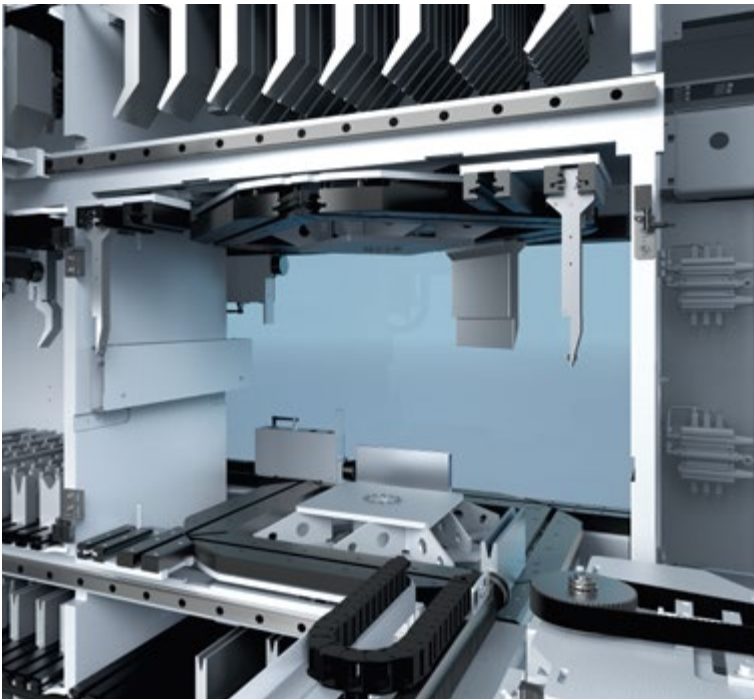

Depending on the component, upper tools have to be set up so they are rotated.



Due to the integrated parking position for the bending aid or support brackets, you can use the space in front of the bending machine optimally depending on the component.

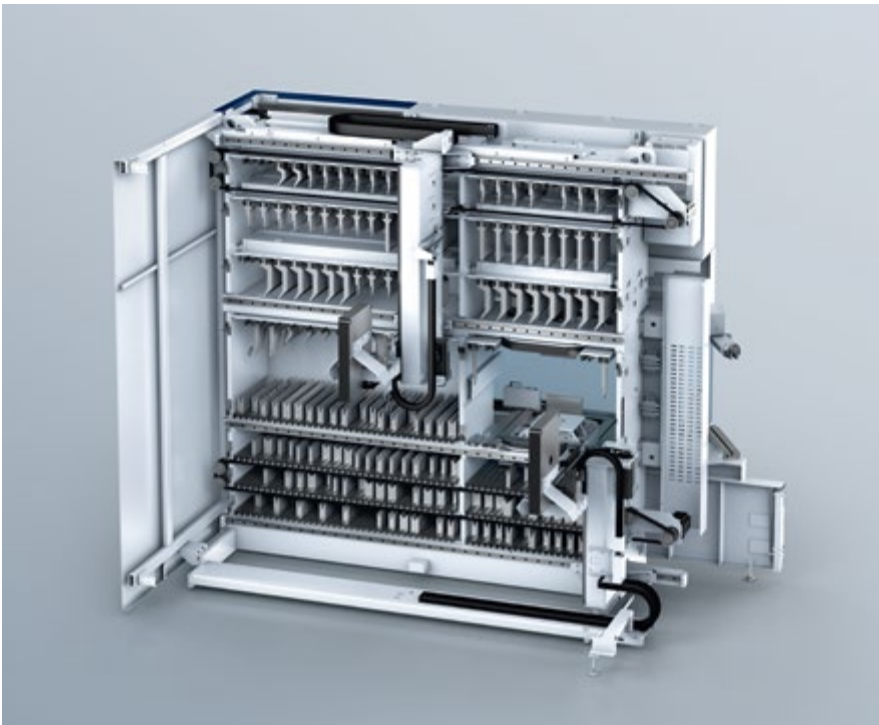

The ToolMaster uses standard tools; you can also use ACB and specialist tools, as well as tools with an adapter.



Find more information about the ToolMaster at www.trumpf.com/s/o8wite



Flex Cell

Covering order peaks and counteracting a shortage of skilled workers: Flex Cell mobile bending automation makes this possible. When urgent orders come in, you can scale up your bending capacity for simple parts in no time.

This is how fast automation can be

Flex Cell bending automation transforms your manual TruBend 7050 into the fastest mobile bending cell from TRUMPF. And it does it without the need for additional personnel. This relieves the strain on your team and enables you to work shifts that are largely autonomous. To do this, simply connect the mobile robot cell to your bending machine as required and benefit from automated bending power in the smallest possible space.

With the Flex Cell, you gain a fully automated bending cell with a generously dimensioned raw material buffer. Thanks to double loading capacity, it provides up to 42 hours of largely autonomous running time. The mobile bending automation allows you to plug and unplug flexibly. Simple components can be manufactured quickly and automatically, while demanding components can be manufactured manually.





With a size of less than 10 m², the TruBend 7050 with Flex Cell fits into any production facility.



If required, the Flex Cell can be docked onto the bending machine by hand...

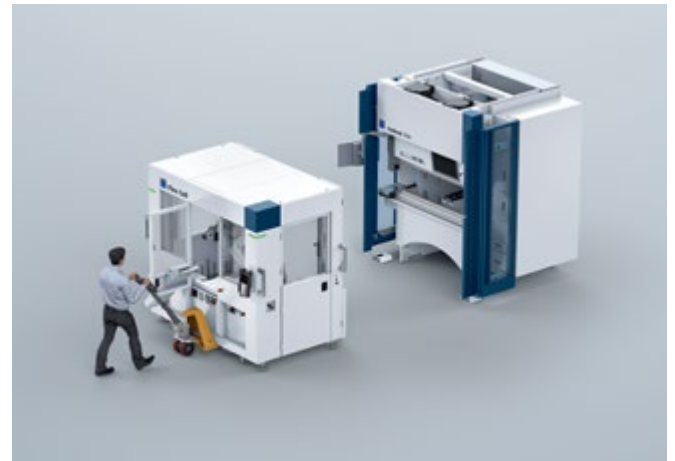

...by pallet jack or forklift truck.



More information on the Flex Cell is available under:
www.trumpf.info/nldych



TruBend Cell 5000

Productive universal bending cell: the ideal solution for anyone who values productive and flexible automation for the widest possible range of parts. Quality remains consistently high.

01

Produce reliably

with in-built intelligence

02

Perfect programming

simple and fast



03

Easy regripping

due to automatic gripper change

04

Shape the material flow

with the appropriate installation version

01

Produce reliably

with in-built intelligence

The big advantage with automatic bending – you can produce reliably and with consistent quality around the clock. This is ensured by a range of factors. The sensor system in the 4-axis or 6-axis backgauge positions your components with precision down to the millimeter. The angle measurement systems ACB Laser and ACB Wireless ensure good parts from the very first part.



You can bend the perfect angles automatically due to ACB Laser and ACB Wireless.

03

Easy regripping

due to automatic gripper change

The right gripper is always used – this is how your TruBend Cell 5000 processes the widest range of orders easily in succession. Depending on the component size, you can combine different gripping technologies for this purpose. You save plenty of time during small part production – blanks are separated parallel to production and transferred over to the pivoted-jaw gripper. You can produce up to four component types in one operation using the rotating sheet removal station, including regripping consoles.



The gripper quickly places the sheet metal on the regripping station, regrips it and lifts it up again.

02

Perfect programming

simple and fast

The programming software TecZone Bend is exciting: You can use it to generate bending programs within the shortest time. Based on 2D and 3D data, TecZone Bend provides the entire programming recommendation, including the NC code. You can intervene at any time and, for example, redefine the picking-up process for the sheet even further or adapt the unstacking strategy. Replace conveyor belts, output pallets or redefine stack heights with just one click.

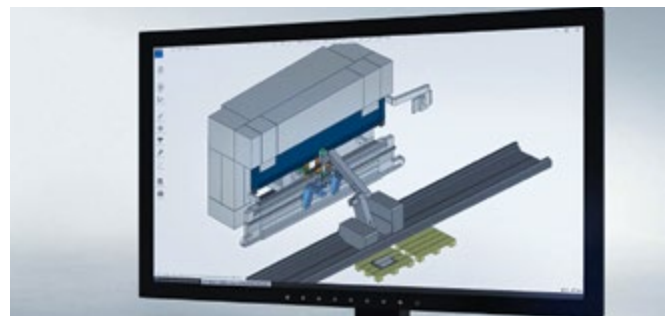

Faster programming with TecZone Bend.

04

Shape material flow

with the right installation version

Want maximum freedom? You can shape the material flow of your TruBend Cell 5000 according to your requirements using conveyor belts and pallet conveyors. A conveyor belt for removal of small, non-stackable parts also increases your productivity. Without interrupting the bending operation, the pallet conveyor loads blanks or unloads finished workpieces. If required, you can also connect your bending cell to a store.



Individually determine the material flow.

Keep a tight grip on your production

Do you need speed and maximum productivity? Should your TruBend Cell 5000 also reliably handle large and heavy parts? In both cases, the grippers with flexible use assist you at the bending cell with precision. This means that the pivoted-jaw gripper with its additional axes works highly productively. Its regripping outlay is minimal. It even holds parts that the suction cup cannot grab effortlessly. In contrast, the suction cup gripper can deal with any dimensions and reliably processes even very large and heavy parts. You can even design and produce suction cup grippers yourself cheaply.



Gripper changing console



Sheet removal station with rotary table



Pivoted-jaw gripper with moving and rotary axis



BendMaster (60) with fine-position recognition

Go with the flow

How long should your floor lane be? Where would you like to have how many pallet spaces? A bending cell can be tailored precisely to your components and your production volume. This page shows some installation versions.

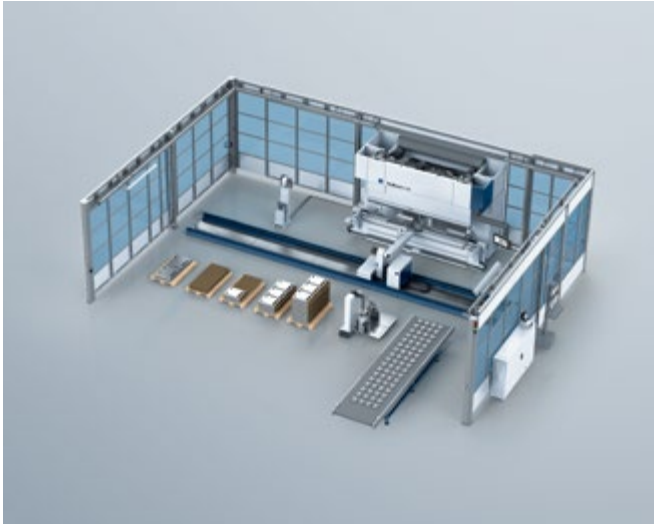

TruBend 5130 with BendMaster (60), 10 m path, sheet removal station, conveyor belt and gripper changing console.

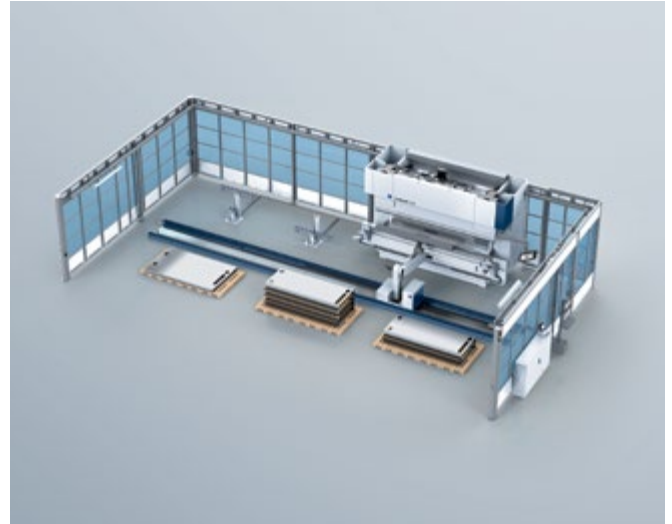

TruBend 5230 with BendMaster (150), 14 m path and gripper changing consoles.

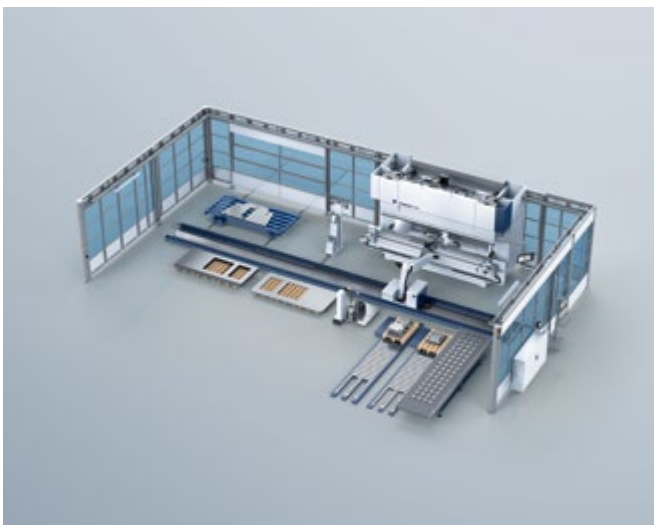

TruBend 5170 with BendMaster (60), 12 or 14 m path, sheet removal station with rotary table, two gripper changing consoles, ToolMaster, conveyor belt and two pallet conveyors.

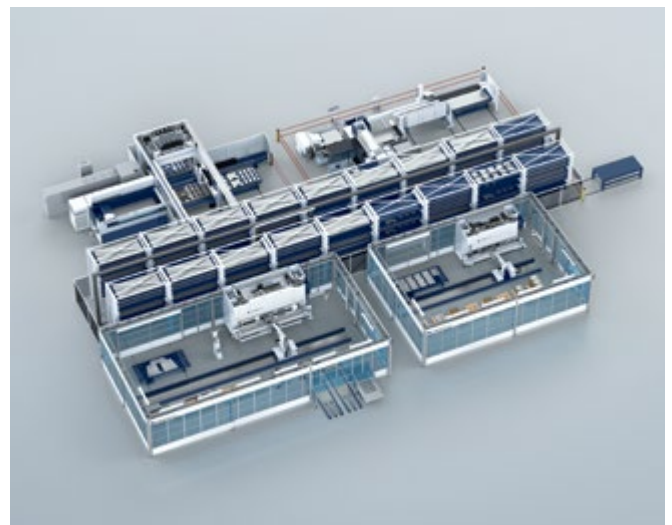

TruBend 5170 with BendMaster (60), 12 or 14 m path, sheet removal station with rotary table, two gripper changing consoles, conveyor belt and two pallet conveyors with storage connection.

Did you know?

Your TruBend Series 5000 machine can be upgraded to an automatic bending cell at a later date.



Find more information about the TruBend Cell 5000 at www.trumpf.com/5/sqlo04



TruBend Cell 5000 Lean Edition

The economical productive bending cell provides impressively powerful and flexible automation for a wide range of parts. High-quality bending with ease – thanks to easy programming and the gripper change.

01

Easy retrofitting

thanks to the automatic gripper change

02

Secure grip

with the help of sheet sensors



03

Versatile production

with gripper technology

04

Simple programming

fast and safe

01

Easy retrofitting

thanks to the automatic gripper change

The pivoting-jaw gripper helps to bend small components automatically. Regripping requires less time thanks to the linear and rotary axis. The console automatically replaces grippers and can automatically execute orders without manual intervention.



Finish orders without manual intervention and save time.

03

Versatile production

with gripper technology

Bend small, medium-sized parts and parts weighing up to 40 kg using the variably adjustable gripper and vacuum gripping technology. This makes complex gripper construction a thing of the past. You can configure your multigripper in just a few minutes in the TRUMPF offline programming system. With a few simple steps, you can adapt it to the geometry of the component. Your added value: significantly reduced non-productive time. This frees up capacity for specialists to perform value-adding tasks.



Quick-release fasteners allow you to adjust your multigripper in just a few simple steps.

02

Secure grip

with the help of sheet sensors

A sheet sensor helps the gripper to pick up the blanks correctly. The fine position recognition is another advantage: Sheet sensors detect the precise position of your components and ensure that they are picked up precisely. A special centering station is no longer required.

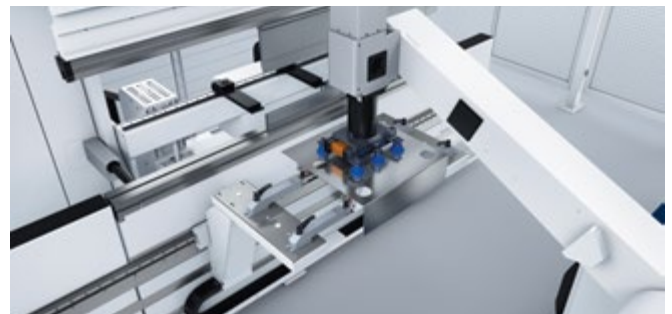

Thanks to sheet metal sensors and fine position recognition, your parts are always bent with precision.

04

Simple programming

fast and secure

With the tried-and-tested TecZone Bend software, you can program your bending program extremely quickly. It calculates your bending programs in no time – and is easy to use.



You can find more information about the TruBend Cell 5000 Lean Edition at www.trumpf.info/ouam6s



TruBend Cell 7000

The innovative high-speed bending cell – you can bend small parts dynamically and extremely cost-efficiently with the quickest system in the world.

01

Minimal costs

per bend

02

More productive

due to clever gripper

03

Compact

minimal space required

04

Well thought out

optimum material flow



01

Minimal costs

per bend

The part throughput of a TruBend Cell 7000 is twice as high as in a conventional bending cell. Quick individual components and harmonious processes make the bending cell dynamic. From the divided tool clamp and tool changer to offline programming – the interplay of innovative functions enables cycle times of just four to six seconds per bend. This allows you to bend with unparalleled low part costs.



High part number in no time – that is the TruBend Cell 7000.

03

Compact

minimal space required

With an installation area of just 5.5 by 3.9 m, the TruBend Cell 7000 fits in any production. In addition to the space-saving installation, operation has also been thought out to the smallest detail. You can therefore load and unload your bending cell easily from the same side. Use precisely the installation variant within the small cell that suits your requirements.



Perfectly attuned – machine and BendMaster.

02

More productive

due to clever gripper

The tool clamp of the TruBend Cell 7000 is divided so that the robot arm of the BendMaster can grip directly through it. This minimizes regripping outlay and allows your cell to work even more quickly and productively. The pivoted-jaw gripper is available in multiple versions; which one is most suitable for you depends on your applications.



The tool is correctly picked up and quickly positioned.

04

Well thought out

optimum material flow

Two synchronized robots load your machine at the same time – the ToolMaster sets up automatically and the LoadMaster Bend loads quickly, reliably and parallel to production. With the aid of a connector system, the system pallets provide up to 24 different components here. Finished parts are placed in boxes with different sections or discharged onto the pallet conveyor. The gentle conveyor belt is suitable for scratch-prone parts. The storage capacity is large enough that you can produce entirely without an operator over a long period of time.



A conveyor system is available for storing finished parts.

Optimum processes

Automatic helpers ensure a smooth material flow around your bending cell. The ToolMaster sets it up automatically with the appropriate tools. The sensor system identifies the tool type and its position. This means that you can arrange the bending tools in the ToolMaster in any manner. It pays off especially with small lot sizes – your machine processes different orders without you having to deploy staff. The LoadMaster doesn't just load your system with blanks parallel to production. An

integrated sheet sensor also measures the blanks optically and transfers them to the BendMaster in exactly the right position. Finished parts land on a conveyor system; from there they are either transferred into boxes or are discharged via the pallet conveyor. You can produce without an operator over a long period of time due to the large storage capacity. The TruBend Cell 7000 is also space-saving and can be loaded and unloaded from the same side.

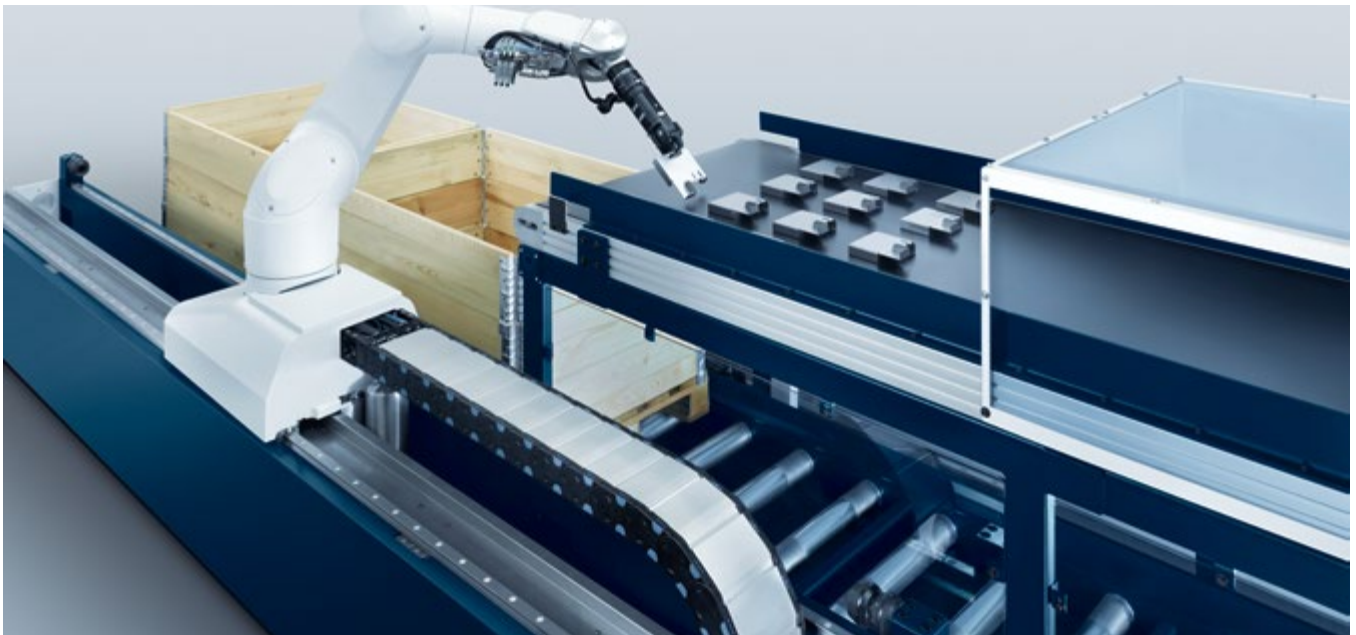

Conveyor system with conveyor belt and pallet conveyor



ToolMaster



LoadMaster with system pallet

Arranged according to your requirements

Whether you want to have your finished parts sorted into boxes or discharged via a gentle conveyor belt – all components of your TruBend Cell 7000 can be put together perfectly in accordance with your requirements. This page shows possible versions as examples.



TruBend Cell 7000 with BendMaster (15) and LoadMaster.



TruBend Cell 7000 with BendMaster (15), LoadMaster, ToolMaster and conveyor belt.

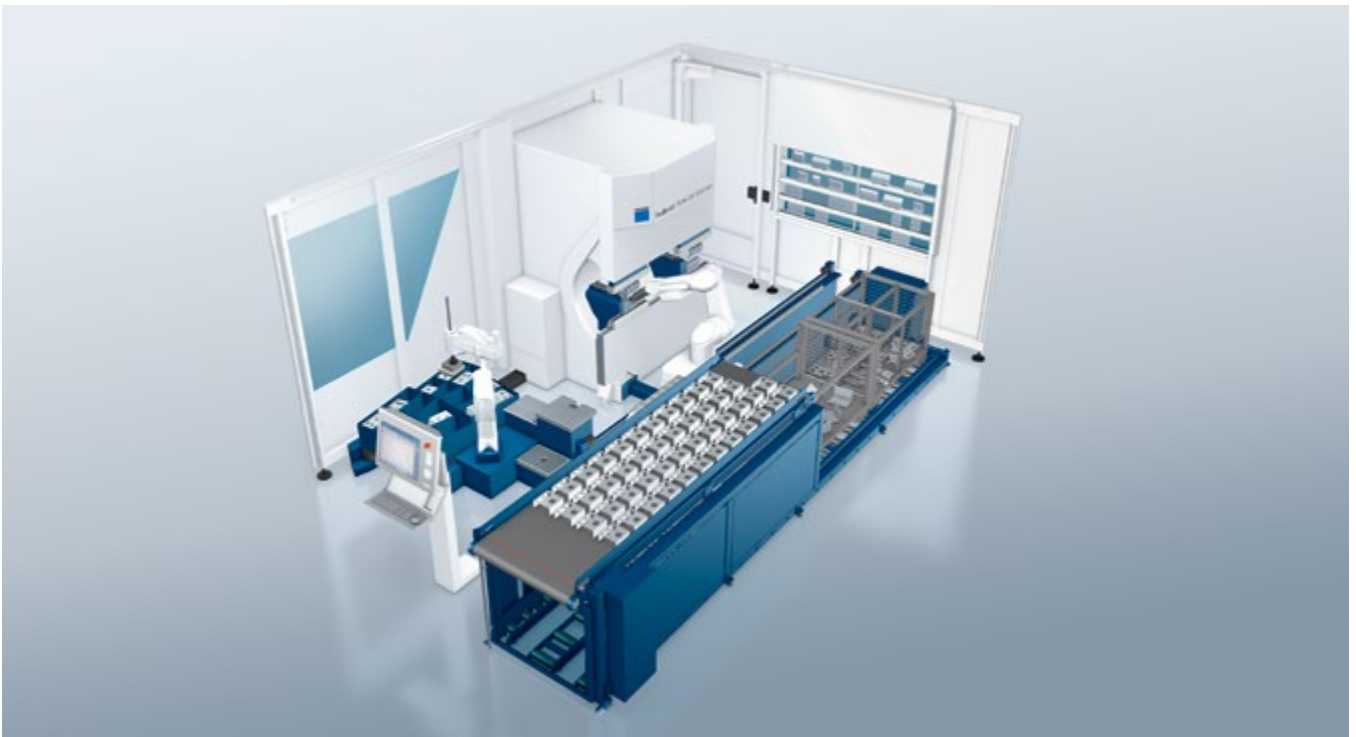

TruBend Cell 7000 with BendMaster (15), LoadMaster, ToolMaster and conveyor system.



Find more information about the TruBend Cell 7000
at www.trumpf.com/Israelnm





Technical data

We have summarized the most important technical data of the TruBend machines for you on the following pages.

TruBend 1100 Classic Model, TruBend 1100 Comfort Model,
TruBend 1150 Classic Model, TruBend 1150 Comfort Model

		TruBend 1100 Classic Model	TruBend 1100 Comfort Model	TruBend 1150 Classic Model	TruBend 1150 Comfort Model
Press force	kN	1000	1000	1500	1500
Width between columns	mm	3100	3100	3100	3100
Freier Ständerdurchgang	mm	2700	2700	2700	2700
Max. table/press beam distance	mm	575	575	575	575
Usable open height with manual and hydraulic tool clamp	mm	380	400	380	400
Working height ^[1]	mm	910	910	910	910
Throat depth	mm	410	410	410	410
Press beam inclined position	mm	± 10	± 10	± 10	± 10
Speeds^[2]					
Y axis rapid traverse ^[3]	mm/s	220	220	180	180
Max. Y axis operation	mm/s	10	10	10	10
Y axis return speed	mm/s	170	170	150	150
X axis	mm/s	400	400	400	400
R axis	mm/s	200	200	200	200
Z axis	mm/s	1000	1000	1000	1000
Precision					
Y axis	mm	0.01	0.01	0.01	0.01
X axis	mm	0.05	0.05	0.05	0.05
R axis	mm	0.1	0.1	0.1	0.1
Traverse paths					
Y axis stroke	mm	200	200	200	200
X axis traverse path	mm	500	500	500	500
Max. stop range in X direction	mm	880	880	880	880
R axis traverse path	mm	200 (50 – 250)	200 (50 – 250)	200 (50 – 250)	200 (50 – 250)
Control		RA-Control	RA-Control	RA-Control	RA-Control
Dimensions and weight					
Length x width	mm	3790 x 1910	3790 x 1910	3790 x 2035	3790 x 2035
Height	mm	2545	2545	2545	2545
Weight	kg	8350	8350	9600	9600

^[1]With lower tool height of 100 mm. Working height varies depending on the height of the material being set up on the machine.

^[2]Traverse speed can be freely programmed.

^[3]With BendGuard (option).

Subject to alteration. Only specifications in our offer and order confirmation are binding.

TruBend 1225 Classic Model, TruBend 1225 Comfort Model,
TruBend 3066, TruBend 3100, TruBend 3170

		TruBend 1225 Classic Model	TruBend 1225 Comfort Model	TruBend 3066	TruBend 3100	TruBend 3170
Press force	kN	2250	2250	660	1000	1700
Bending length	mm	4100	4100	2040	3060	4080
Width between columns	mm	3700	3700	2364	3384	4404
Max. table/press beam distance	mm	575	575	470	470/620 ^[1]	620
Usable open height with manual and hydraulic tool clamp	mm	380	400	350	350/500 ^[1]	500
Usable open height with TRUMPF QuickClamp	mm	950	950	430	430/580 ^[1]	580
Working height ^[2]	mm	950	950	1049–1069	1049–1069	1049–1069
Throat depth	mm	410	410	–	–	–
Press beam inclined position	mm	± 10	± 10	± 3	± 6.5	± 7.5
Speeds^[3]						
Y axis rapid traverse ^[4]	mm/s	170	170	200	200	170
Max. Y axis operation	mm/s	10	10	15	15	15
Y axis return speed	mm/s	140	140	200	200	170
X axis	mm/s	400	400	500	500	500
R axis	mm/s	200	200	200	200	200
Z axis	mm/s	1000	1000	1000	1000	1000
Precision						
Y axis	mm	0.01	0.01	0.01	0.01	0.01
X axis	mm	0.05	0.05	0.05	0.05	0.05
R axis	mm	0.1	0.1	0.1	0.1	0.1
Traverse paths						
Y axis stroke	mm	205	205	200	200/350 ^[1]	350
X axis traverse path	mm	500	500	600	600	600
Max. stop range in X direction	mm	880	880	860	860	860
R axis traverse path	mm	200 (50–250)	200 (50–250)	150	150	150
Control		RA control	RA control	T3500T	T3500T	T3500T
Dimensions and weight						
Length x width	mm	4780 x 2080	4780 x 2080	2587 x 1644	3607 x 1644	4647 x 1644
Height	mm	2900	2900	2370	2370/2720 ^[1]	2925
Weight	kg	15000	15000	5650	7700/8300 ^[1]	15000

^[1]With increased open height (option).

^[2]With lower tool height of 100 mm. Working height varies depending on the height of the material being set up on the machine.

^[3]Traverse speed can be freely programmed.

^[4]With BendGuard (option).

Subject to alteration. Only specifications in our offer and order confirmation are binding.

TruBend 5085, TruBend 5130, TruBend 5170, TruBend 5230, TruBend 5320, TruBend 7036,
TruBend 7050

		TruBend 5085	TruBend 5130	TruBend 5170	TruBend 5230	TruBend 5320	TruBend 7036	TruBend 7050
Press force	kN	850	1300	1700	2300	3200	360	500
Bending length	mm	2210/2720 ^[1]	3230	3230/4250 ^[1]	3230/4250 ^[1]	4420	1020	1530
Width between columns	mm	1750/2260 ^[1]	2690	2690/3680 ^[1]	2690/3680 ^[1]	3680	932	1305
Max. table/press beam distance	mm	505/735 ^[1]	505/735 ^[1]	735	735	735	420	505
Usable open height	mm	385/615 ^[1]	385/615 ^[1]	615	615	615	295	385
Throat depth	mm	420	420	420	420	420	150	250
Working height	mm	1095–1115 ^[2]	1095–1115 ^[2]	1095–1115 ^[2]	1095–1115 ^[2]	1110–1130 ^[2]	1150 ^[7]	1150 ^[7]
Press beam inclined position	mm	± 10	± 10	± 10	± 10	± 10	n/a	n/a
Speeds^[3]								
Y axis rapid traverse	mm/s	220	220	220	220	220	220	220
Y axis press operation	mm/s	max. 25 ^[4]	max. 25 ^[4]	max. 25 ^[4]	max. 25 ^[4]	max. 25 ^[4]	max. 25 ^[8]	max. 25 ^[8]
Y axis return speed	mm/s	220	220	220	220	220	220	220
X axis ^[5]	mm/s	1000/1750	1000/1750	1000/1750	1000/1750	1000/1750	1500	1500
R axis	mm/s	330	330	330	330	330	750	750
Z axis ^[5]	mm/s	1750/2500	1750/2500	1750/2500	1750/2500	1750/2500	2200	2200
Precision								
Y axis	mm	0.005	0.005	0.005	0.005	0.005	0.002	0.002
X axis	mm	0.04	0.04	0.04	0.04	0.04	0.02	0.02
R axis	mm	0.08	0.08	0.08	0.08	0.08	0.06	0.06
Traverse paths								
Y axis stroke	mm	215/445 ^[1]	215/445 ^[1]	445	445	445	120	215
X axis traverse path	mm	600	600	600	600	600	240	240
Max. stop range in X ^[5]	mm	860/1000	860/1000	860/1000	860/1000	860/1000	500	500
R axis traverse path	mm	250	250	250	250	250	153	153
User interface		Touchpoint Bend	Touchpoint Bend	Touchpoint Bend	Touchpoint Bend	Touchpoint Bend	Touchpoint Bend	Touchpoint Bend
Dimensions and weight^[6]								
Length × width	mm	3020 × 1800 3530 × 1800 ^[1]	3980 × 1800	3980 × 1900 4970 × 1900 ^[1]	4150 × 2055 5140 × 2055 ^[1]	5180 × 2055	1900 × 1340	2420 × 1805
Height	mm	2375/2835 ^[1]	2375/2835 ^[1]	3000	3200	3200	2380	2580
Weight	kg	8000/8700 ^[1]	10700/ 11800 ^[1]	14150/ 17850 ^[1]	17200/ 19850 ^[1]	23400	3500	5500

^[1]Second value for the enlarged design respectively (option).

^[2]With lower tool height of 100 mm. Working height varies depending on the height of the material being set up on the machine.

^[3]Traverse speed can be freely programmed.

^[4]With working speed of 10 mm/s.

^[5]Depending on the selected backgauge.

^[6]Data relates to the basic machine without options.

^[7]With 100 mm die height.

^[8]Dependent on the die width and application. Dependent on local regulations.

Subject to alteration. Only specifications in our offer and order confirmation are binding.

TruBend 8230, TruBend 8320, TruBend 8400, TruBend 8500,
TruBend 8600, TruBend 8800, TruBend 81000

		TruBend 8230	TruBend 8320	TruBend 8400	TruBend 8500	TruBend 8600	TruBend 8800	TruBend 81000
Press force	kN	2300	3200	4000	5000	6000	8000	10000
Bending length	mm	4050/5050/ 6050	5050/ 6050	4050/5050/ 6050	4050	5050/6050	6050/7050/ 8050	7050/8050
Width between columns	mm	3550/4050/ 5050	4050/5050	3550/4050/ 5050	3050	4050/5050	5050/6050/ 7050	6050/7050
Surface-mounted design		Yes	Yes	Yes/yes/-	Yes	-	-	-
Max. table/press beam distance ^[2]	mm	820/1020 ^[1]	820/1020 ^[1]	820/1020 ^[1]	820/1020 ^[1]	820/1020 ^[1]	820/1020 ^[1]	820/1020 ^[1]
Usable open height	mm	675/875 ^[1]	675/875 ^[1]	675/875 ^[1]	675/875 ^[1]	675/875 ^[1]	675/875 ^[1]	675/875 ^[1]
Throat depth	mm	420/620 ^[1]	420/620 ^[1]	420/620 ^[1]	420/620 ^[1]	420/620 ^[1]	420/620 ^[1]	420/620 ^[1]
Working height	mm	1165	1165	1065/1165/ 1065	1065	1015	1015	965
Press beam inclined position	mm	± 10	± 10	± 10	± 10	± 10	± 10	± 10
Speeds								
Y axis rapid traverse	mm/s	220	150	170	160	120	140	100
Y axis press operation	mm/s	10	10	10	10	9	10	8
Y axis return speed	mm/s	220	150/120	170	160	120	140	100
X axis ^[3]	mm/s	1000	1000	1000	1000	1000	1000/800/ 800	800
R axis ^[3]	mm/s	200	200	200	200	200	200/140/ 140	140
Z axis ^[3]	mm/s	1000	1000	1000	1000	1000	1000/800/ 800	800
Precision								
Y axis	mm	0.01	0.01	0.01	0.01	0.01	0.01	0.01
X axis ^[3]	mm	0.02	0.02	0.02	0.02	0.02	0,02	0.02
R axis ^[3]	mm	0.05	0.05	0.05	0.05	0.05	0.05	0.05
Traverse paths								
Y axis stroke	mm	500/700 ^[1]	500/700 ^[1]	500/700 ^[1]	500/700 ^[1]	500/700 ^[1]	500/700 ^[1]	500/700 ^[1]
X axis traverse path ^[3]	mm	600	600	600	600	600	600	600
Max. stop range ^[3] in X	mm	1000	1000	1000	1000	1000	1000	1000
R axis traverse path ^[3]	mm	200	200	200	200	200	200	200
Control		T8000T multi-touch	T8000T multi-touch	T8000T multi-touch	T8000T multi-touch	T8000T multi-touch	T8000T multi-touch	T8000T multi-touch
Dimensions and weight available on request								

^[1] Values for the enlarged design (option).

^[2] Values for tool clamp with max. load of 3000 kN/m.

^[3] Values apply to 2-, 4- and 5-axis backgauge.

Subject to alteration. Only specifications in our offer and order confirmation are binding.

2 × TruBend 8230 (4 m), 2 × TruBend 8320 (3 m), 2 × TruBend 8400 (4 m), 2 × TruBend 8500 (4 m),
TruBend Cell 5000 with BendMaster (60), TruBend Cell 5000 with BendMaster (150),
TruBend Cell 7000 with BendMaster (15)

Tandem system		2 × TruBend 8230 (4 m)	2 × TruBend 8320 (3 m)	2 × TruBend 8400 (4 m)	2 × TruBend 8500 (4 m)
Press force	kN	2 × 2300	2 × 3200	2 × 4000	2 × 5000
Electrical connection (approx.)	kVa	2 × 35	2 × 44	2 × 53	2 × 62
Bending length	mm	8100	6100	8100	8100
Width between columns	mm	3050	2050	3050	3050
Max. clearance between table – press beam ^[2]	mm	820	820	820	820
Usable open height	mm	675	675	675	675
Throat depth	mm	820	820	820	820
Length	mm	9190	7210	9250	9290

The TruBend Series 8000 is available in four designs, whereby the left and right machine types are always the same. Other lengths/tonnages available on request. Subject to alteration. Only specifications in our offer and order confirmation are binding.

		TruBend Cell 5000 with BendMaster (60)	TruBend Cell 5000 with BendMaster (150)
Max. component size	mm	2000 × 1000	3000 × 1500
Profiles	mm	up to 2500	up to 4000
Max. component weight	kg	40	100
Max. carrying capacity	kg	60	150
Min. sheet thickness	mm	0.7	0.7
Path length	m	8–16	8–16
Max. blank stack	mm	700	700
Max. stack height for finished parts	mm	1000	1200
TruBend Series 5000		5130 to 5320	5130 to 5320

Subject to alteration. Only specifications in our offer and order confirmation are binding.

		TruBend Cell 7000 with BendMaster (15)	
Maximum component size	mm	500 × 380	
Maximum sheet thickness	mm	6	
Max. component weight	kg	3 ^[1]	
Max. carrying capacity	kg	15	
Press force	kN	360	
Working speed	mm/s	up to 50	
Dimensions	mm	5500 × 3870	

Subject to alteration. Only specifications in our offer and order confirmation are binding.

^[1]At reduced speed.

^[2]Values for tool clamp with max. load of 3000 kN/m.

Spotlight: Panel bending

In addition to die bending, TRUMPF provides another technology – panel bending. This allows you to achieve multidimensional workpieces with minimum flange lengths, high boxes, small profiles, formed sections, recesses, diverse radii and multiple negative bends quickly and with flexibility.

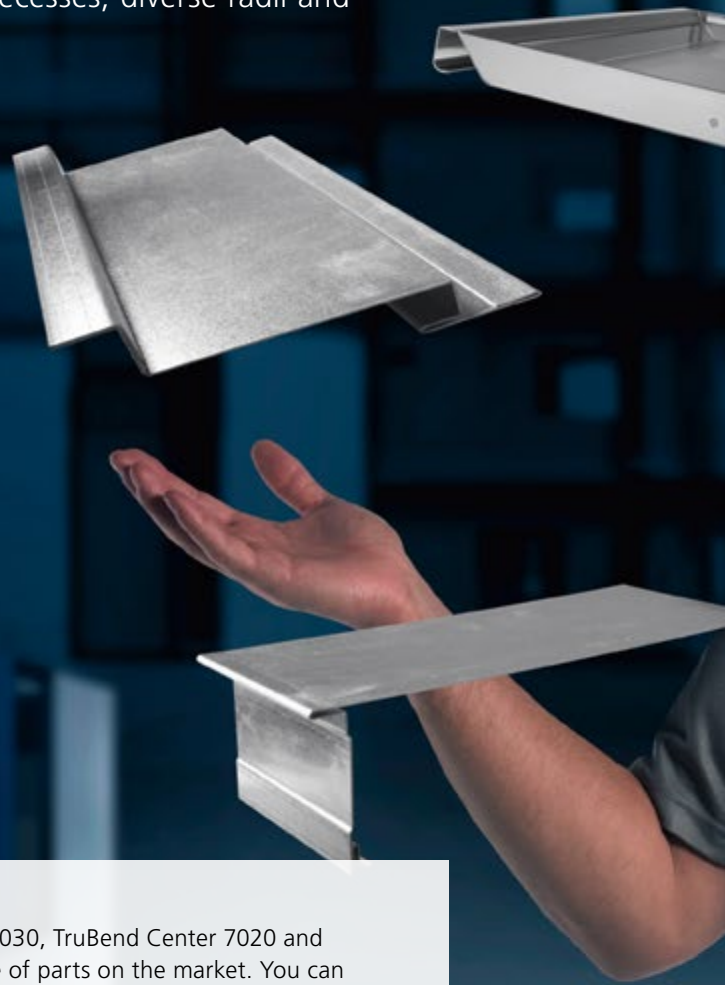

Whether semi-automatic or fully automatic: With the TruBend Center 5030, TruBend Center 7020 and TruBend Center 7030 panel benders, you can discover the widest range of parts on the market. You can therefore also create particularly complex components in addition to the traditional panel bending range. From delicate cases to large tanks, components for the widest range of industry branches and applications are created.





Find more information about the TruBend Center 7030 at www.trumpf.com/s/fk8ucb
Find more information about the TruBend Center 5030 at www.trumpf.com/s/lphtf



TruServices. Your Partner in Performance

To ensure your future success, you need services that definitely put you ahead of the pack for the long term. Whether that means creating the best conditions for successful production, or using your TRUMPF bending machine perfectly to adapt to changes with flexibility – together we'll find ways to sustainably maximize your value creation. As a reliable partner, we will provide you with comprehensive solutions and service packages for your requirements – so that you can produce cost-efficiently and at a constantly high level.

EMPOWER

When you would like to create optimal conditions for production success: We will help you with that. If you are well trained, you can fully utilize the potential of your lasers, laser systems, machines and software, and secure key competitive advantages. In the laser cutting technology course, for example, you learn how to obtain the best possible cutting quality and determine piercing parameters for special materials.

SUPPORT

If flexibility and system availability in ongoing operation are a must for you, we are there for you. Whether it's a technical problem, software, a spare part or a question concerning maintenance: with the Service app and your free MyTRUMPF account, you can send your service messages quickly and easily to our Technical Service team at any time.

IMPROVE

If you want to gradually focus your production on maximum value creation, Together we will achieve your goal. Where system maintenance and servicing are concerned, you will benefit from expert support of the highest quality. Ensure constant maximum machine availability, consistently high production quality, and low operating costs with service agreements from TRUMPF.



Find more information about TruServices
at www.trumpf.com/s/services



Passion is what drives us

Whether it's production and manufacturing technology, laser technology, or material processing – we develop highly innovative products and services for you which are tailored to your industry and which are absolutely proven and reliable. We put everything we've got into giving you a compelling, competitive edge: expertise, experience, and above all passion.



Check out our
YouTube channel:
[www.youtube.com/
@TRUMPFtube](http://www.youtube.com/@TRUMPFtube)



Machines & systems

Laser cutting, punching, bending, laser welding: With custom-fit machine tools, laser systems and automation from TRUMPF, you can master flexible sheet metal and tube processing. Not forgetting our solutions for additive manufacturing.



Lasers

Whether you are cutting, welding, marking or processing surfaces, lasers from TRUMPF are the universal tools for industrial applications – in the macro, micro and nano ranges. In addition, you will get software solutions and benefit from application knowledge and consulting.

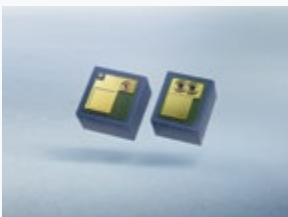

VCSEL solutions & photodiodes

Laser and photodiodes from TRUMPF Photonic Components come into their own in numerous applications: in both the industrial and consumer markets and even in optical data communication. In the TruHeat VCSEL systems, millions of VCSELs (Vertical Cavity Surface Emitting Laser) generate infrared heat, which is used for laser heat treatment.



Power electronics

Nothing's hi-tech without a process power supply: With generators for plasma technology, industrial heating, battery inverter systems or microwave amplifiers, you get power at the frequency and performance you need.



Solutions for your future

Take advantage of digital networking opportunities: we partner with you on the path to networked production, delivering pragmatic, economical solutions that make your processes both more transparent and flexible.

TRUMPF is certified to ISO 9001
(Find out more: www.trumpf.com/s/quality)

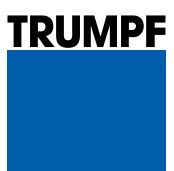

TRUMPF Werkzeugmaschinen SE + Co. KG
www.trumpf.com